



LISTINO PREZZI H-21

04_2021



edilizia



acustica



garden



bins



stampaggio
conto terzi





GRANCHIO

cassero a perdere per la realizzazione di vespai areati



Articolo	Dimensioni in cm.	Consumo di calcestruzzo a riempim. m ³ /m ²	Superficie appoggio di ogni elemento cm ² /m ²	Imballo	Dimensioni imballo in cm.	Prezzo €/m ²
GRA05	60 x 80 x 5h**	0,009	645	pz. 200 = m ² 90	120 x 80 x 214	12,814
GRA10	60 x 80 x 10h**	0,015	580	pz. 160 = m ² 72	120 x 80 x 218	13,520
GRA15B	50 x 75 x 15h	0,030	547	pz. 100 = m ² 37,50	105 x 77 x 200	14,516
GRA20B	50 x 75 x 20h	0,035	453	pz. 100 = m ² 37,50	105 x 77 x 205	15,237
GRA25B	50 x 75 x 25h	0,040	599	pz. 100 = m ² 37,50	105 x 77 x 215	15,957
GRA30B	50 x 75 x 30h	0,045	474	pz. 100 = m ² 37,50	105 x 77 x 220	16,676
GRA35	50 x 75 x 35h	0,050	495	pz. 100 = m ² 37,50	105 x 77 x 225	17,397
GRA40B	50 x 75 x 40h	0,055	467	pz. 100 = m ² 37,50	105 x 77 x 230	18,117
GRA45	50 x 75 x 45h	0,060	439	pz. 100 = m ² 37,50	105 x 77 x 235	18,554
GRA50B	50 x 75 x 50h	0,065	411	pz. 90 = m ² 33,75	105 x 77 x 220	19,558
GRA55	50 x 75 x 55h	0,070	383	pz. 90 = m ² 33,75	110 x 77 x 230	20,343

** Dimensioni utilizzo: 0,58x0,78=m² 0,45



PROFILI

Articolo	Dimensioni in cm.	Prezzo €/ml
PRO10	200 x 17	1,510
PRO15	200 x 23	2,337
PRO20	200 x 28	2,821
PRO25	200 x 33	3,316
PRO30	200 x 38	3,802
PRO35	200 x 43	4,295
PRO40	200 x 48	4,792
PRO45	200 x 53	5,276
PRO50	200 x 58	7,612
PRO55	200 x 63	8,343



MINIHERCULES

il cassero che risolve tutte le problematiche delle medie altezze



Articolo	Dimensioni in cm.	Consumo di calcestruzzo a riempim. m ³ /m ²	Superficie appoggio di ogni elemento cm ² /m ²	Dimensioni imballo cm.	Prezzo €/m ²
GRA55M	50 x 75 x 55h	0,062	320	80 x 120 x 234	24,179
GRA60M	50 x 75 x 60h	0,064	320	80 x 120 x 234	24,665
GRA65M	50 x 75 x 65h	0,066	320	80 x 120 x 234	25,140
GRA70M	50 x 75 x 70h	0,068	320	80 x 120 x 234	25,625



HERCULES E SUPERHERCULES

per soddisfare le più svariate esigenze di altezza



Articolo	Dimensioni in cm.	Consumo di calcestruzzo a riempim. m ³ /m ²	Superficie appoggio di ogni elemento cm ² /m ²	Dimensioni imballo cm.	Prezzo €/m ²
HER 75	50 x 75 x 75h	0,070	320	105 x 77 x 232	34,249
HER 80	50 x 75 x 80h	0,072	320	105 x 77 x 232	34,485
HER 85	50 x 75 x 85h	0,074	320	105 x 77 x 232	34,732
HER 90	50 x 75 x 90h	0,076	320	105 x 77 x 232	34,980
HER 95	50 x 75 x 95h	0,078	320	105 x 77 x 232	35,229
HER 100	50 x 75 x 100h	0,080	320	105 x 77 x 232	35,476
SUPERHER 105	50 x 75 x 105h	0,140	320	105 x 77 x 230	38,297
SUPERHER 110	50 x 75 x 110h	0,141	320	105 x 77 x 230	38,910
SUPERHER 115	50 x 75 x 115h	0,143	320	105 x 77 x 230	39,525
SUPERHER 120	50 x 75 x 120h	0,145	320	105 x 77 x 230	40,138
SUPERHER 125	50 x 75 x 125h	0,146	320	105 x 77 x 230	40,751
SUPERHER 130	50 x 75 x 130h	0,148	320	105 x 77 x 230	41,365

I prezzi dei singoli articoli si intendono per un elemento completo. (rapporto BASE/GAMBA = 1:1)



BASE E GAMBA

Articolo	Descrizione	Imballo	Dim. imballo cm	Prezzo €
BASE	Base per hercules e minihercules cm. 50 x 75 x 25	90 pz. = 33,75 m ²	77 x 105	m² 18,528
BASEH	Base per super hercules cm. 50 x 75 x 55	90 pz. = 33,75 m ²	77 x 105	m² 23,934
GAM55	Gamba per minihercules 55	432 pz. = 162,00 m ²	80 x 120	pz. 3,104
GAM60	Gamba per minihercules 60	360 pz. = 135,00 m ²	80 x 120	pz. 3,287
GAM65	Gamba per minihercules 65	252 pz. = 94,50 m ²	80 x 120	pz. 3,468
GAM70	Gamba per minihercules 70	180 pz. = 67,50 m ²	80 x 120	pz. 3,656
GAM75	Gamba per herc 75 e sup herc 105	216 pz. = 81,00 m ²	80 x 120	pz. 5,942
GAM80	Gamba per herc 80 e sup herc 110	198 pz. = 72,37 m ²	80 x 120	pz. 6,100
GAM85	Gamba per herc 85 e sup herc 115	180 pz. = 67,50 m ²	80 x 120	pz. 6,348
GAM90	Gamba per herc 90 e sup herc 120	162 pz. = 60,75 m ²	80 x 120	pz. 6,597
GAM95	Gamba per herc 95 e sup herc 125	144 pz. = 54,00 m ²	80 x 120	pz. 6,820
GAM100	Gamba per herc 100 e sup herc 130	126 pz. = 47,25 m ²	80 x 120	pz. 7,070



CRAWL

per la realizzazione di pavimenti forati in c.a.



Articolo	Dimensioni in cm.	Consumo calcestruzzo a riemp. m ³ /m ²	Imballo (pz)	Dimensioni imballo cm.	Prezzo €/m ²
CR27	58 x 58 x 27h	0,047	240 = 76,8 m ²	120 x 120 x 230h	24,862
CR30	58 x 58 x 30h	0,050	240 = 76,8 m ²	120 x 120 x 235h	25,556
CR35	58 x 58 x 35h	0,055	240 = 76,8 m ²	120 x 120 x 237h	26,003



NOVITA'
2021



SUB

per solai bidirezionali alleggeriti



Articolo	Dimensioni in cm	imballo pz	Dimensioni imballo in cm.	Prezzo €/ pz.
SUB H 16	52 x 52	400	110 x 110	6,763
SUB H 20	52 x 52	360	110 x 110	7,372
SUB H 25	52 x 52	360	110 x 110	7,979
SUB H 30	52 x 52	320	110 x 110	8,598
SUB H 32 (16+16)	52 x 52	400	110 x 110	12,792
SUB H 36 (20+16)	52 x 52	360-400	110 x 110	13,369
SUB H 40 (20+20)	52 x 52	360	110 x 110	13,936
SUB H 41 (25+16)	52 x 52	360-400	110 x 110	13,936
SUB H 45 (25+20)	52 x 52	360	110 x 110	14,596
SUB H 46 (30+16)	52 x 52	320-400	110 x 110	14,785
SUB H 50 (30+20)	52 x 52	320-360	110 x 110	15,401
SUB H 55 (30+25)	52 x 52	320-360	110 x 110	15,833
SUB H 60 (30+30)	52 x 52	320	110 x 110	16,462



elemento doppio



elemento singolo

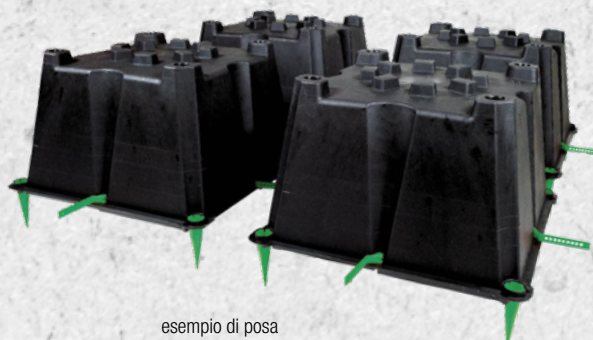

esempio di posa



RAPIDO E TIMPANO

per solai alleggeriti



Articolo	Dimensioni in cm.	Imballo	Dim. imballo cm.	Prezzo €/pz.
RAPIDO H9	79,6 x 55,8 x 11	pz. 140	120 x 80 x 230	5,273
RAPIDO H14	77,0 x 56,5 x 15,5	pz. 140	120 x 80 x 245	5,662



Articolo	Imballo	Dimensioni imballo cm.	Prezzo €/pz.
TIMPANO H9	pz. 220	120 x 80 x 260	1,233
TIMPANO H14	pz. 200	120 x 80 x 260	1,583



Griffe per ancoraggio tiranti per controsoffittatura

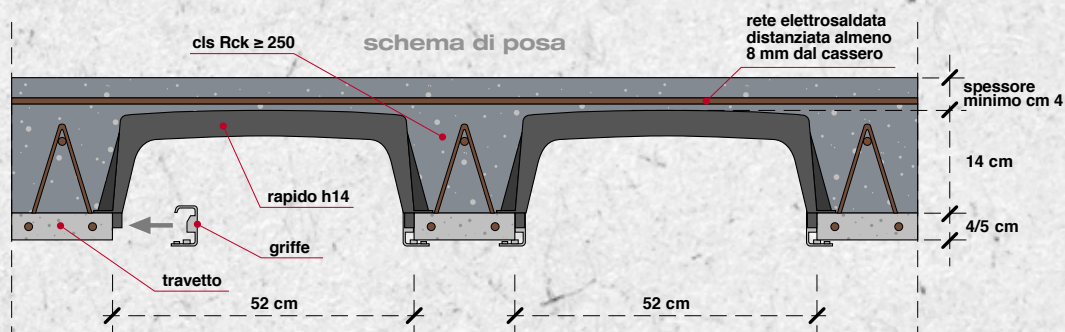

RAPIDO E TIMPANO PRECOMPRESSO

per solai alleggeriti

Articolo	Dim. in cm.	Imballo	Dim. imballo cm.	Prezzo €/pz.
RAPRE H13	76,6 x 54,6 x 13	pz. 200	150 x 110 x 130	5,397
RAPRE H16	76,6 x 54,6 x 16	pz. 200	150 x 110 x 130	6,059
RAPRE H20	76,6 x 54,6 x 20	pz. 200	150 x 110 x 130	6,756



Articolo	Imballo	Dimensioni imballo cm.	Prezzo €/pz.
TIMPAPRE H13	pz. 1200	80 x 120 x 260	1,293
TIMPAPRE H16	pz. 1200	80 x 120 x 260	1,396
TIMPAPRE H20	pz. 1200	80 x 120 x 260	1,501





SKUDO

protezione dei muri contro terra



Articolo	Dimensioni in cm.	Imballo	Dim. imballo cm.	Prezzo €/m ²
SKUDO	60 x 80 x 7,5h	pz.250 = m ² 116,50	120 x 80 x 250	14,977

*Dimensioni utilizzo: 0,59 x 0,79 = m² 0,466

Articolo	Descrizione	Dimensioni in cm.	Prezzo €/ml
PRO SKU	profilo angolare	20 x 20 x 200	3,989
PRO SKU2	profilo doppia L chiusura superiore	5 x 9,5 x 15 x 200	3,989

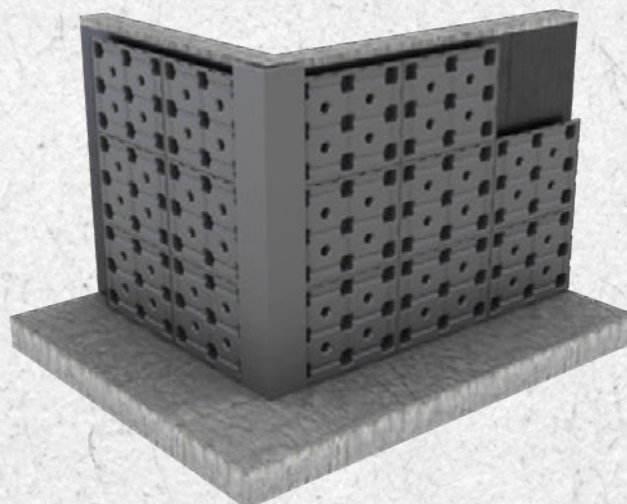

ECOTEGOLA

per coperture leggere civili e industriali



Articolo	Dimensioni in cm.	Imballo	Dimensioni imballo cm.	Prezzo €/m ²
Liberty ST	27,6 x 35,8	24 pz = 2,184 m ²	48sc = 104,832 m ² - 80 x 120 x 245h	26,542
Portoghese ST	25,4 x 32,8	30 pz = 2,310 m ²	24sc = 55,440 m ² - 80 x 120 x 220h	25,754

Liberty ST

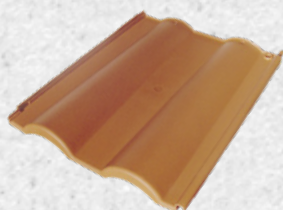

Start up Liberty ST



Portoghese ST



Start up Portoghese ST



Colmo Universale



Start up Colmo Universale



colori disponibili:

● TERRACOTTA

● ANTRACITE

Articolo	Dimensioni in cm.	Prezzo €
Start Up Liberty ST	27,6 x 9	ml. 3,772
Start Up Portoghese ST	25,8 x 8	ml. 4,583
Colmo Universale	17 x 35,4	ml. 4,817
Start Up colmo Univ.	17 x 7	pz. 0,796



GREEN PARKING

per parcheggi e percorsi carrabili inerpati



Articolo	Dimensioni in cm.	Imballo	Dim. imballo cm.	Prezzo €/m ²
GREEN PARKING 40	40 x 40 x 4h	pz.312 = m ² 49,92	120 x 80 x 230	18,873
GREEN PARKING 40 S	40 x 40 x 4h	pz.312 = m ² 49,92	120 x 80 x 230	21,128

*Dimensioni utilizzo: 0,4x0,4 = m² 0,16

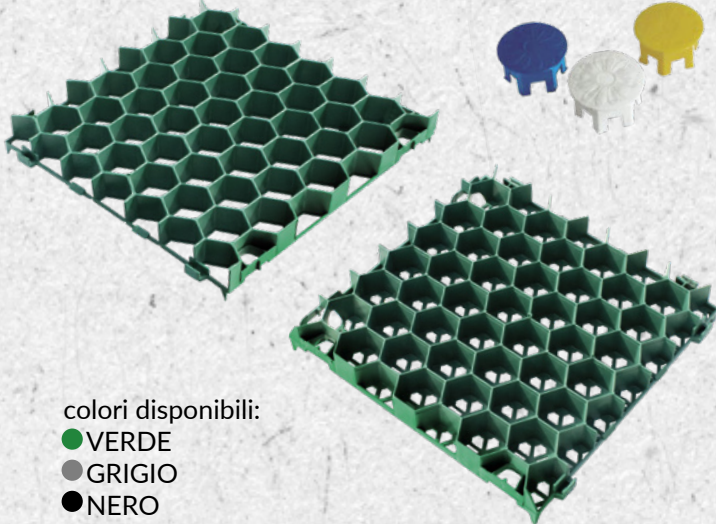

colori disponibili:

- VERDE
- GRIGIO
- NERO

Articolo	Colori disponibili	Imballo	Prezzo €/pz.
MARGHERITA Ø 6,6	bianco, giallo, blu	pz. 350 dim. scatola 40 x 40 x 40 cm	0,566

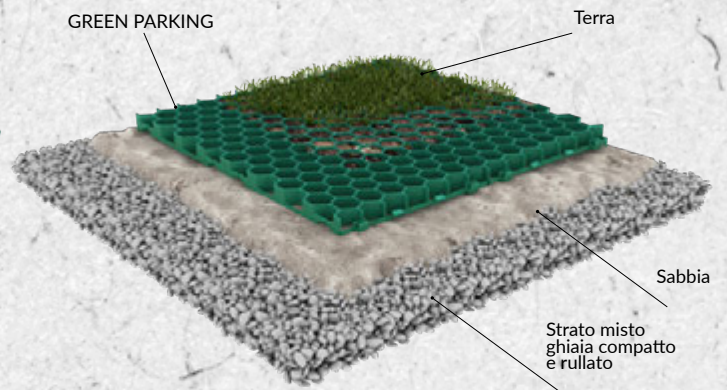

DRAIN FLOOR

per giardini pensili



Articolo	Dim. in cm.	Imballo	Dimensioni imballo cm.	Prezzo €/Mq
DRAIN FLOOR	60 x 80 x 6h*	pz.140 = m ² 63,00	120 x 80 x 225	17,760

*Dimensioni utilizzo: 0,58 x 0,78 = m² 0,45

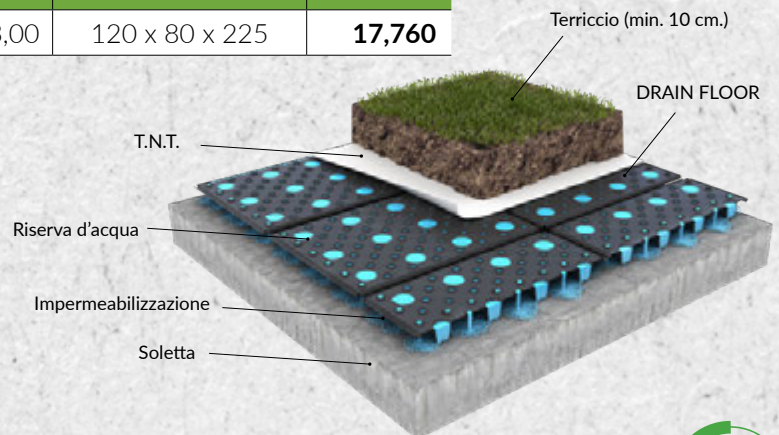
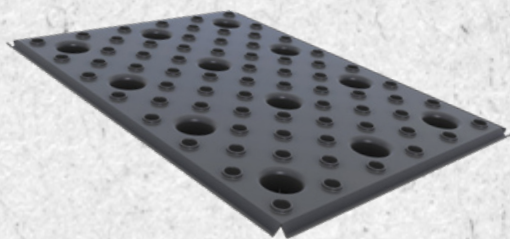

REC FLOOR

piastrella autobloccante multiuso



Articolo	Dim. in cm.	Imballo	Dimensioni imballo cm.	Prezzo €/m ²
REC FLOOR rosso mattone	40 x 20 x 5h	pz. 240	80 x 120 x 120h	36,319
REC FLOOR verde	40 x 20 x 5h	pz. 240	80 x 120 x 120h	36,319
REC FLOOR grigio	40 x 20 x 5h	pz. 240	80 x 120 x 120h	36,319

*Dimensioni utilizzo: 0,08 ** 12 pcs = 0,96 m²

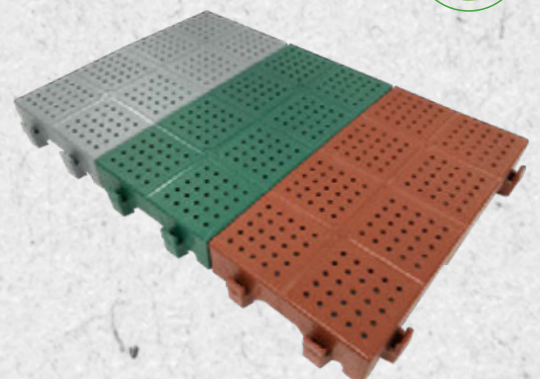



DOMINO

la fioriera componibile modulare



DISEGNO	TIPO	MISURE ESTERNE (cm)	PESO (kg)	LITRI	Prezzo €
	Q1	54 x 54 x 50h	15	112	202,928
	R1	54 x 104 x 50h	25	224	330,569
	R2	54 x 154 x 50h	30	336	458,158
	A1	104 x 104 x 50h	30	336	462,792
	Q2	104 x 104 x 50h	33	448	513,647
	R3	54 x 204 x 50h	40	448	585,746
	T1	104 x 154 x 50h	40	448	595,016
	L1	104 x 154 x 50h	45	672	688,799
	R4	54 x 254 x 50h	50	560	713,335
	D1	154 x 154 x 50h	46	560	717,970
	T2	104 x 204 x 50h	50	672	763,446
	A2	154 x 154 x 50h	50	672	770,776



AGRIGOMMA

tappetino in gomma per il benessere animale



Articolo	Descrizione	Larghezza	Lunghezza	Prezzo €/m ²
AGRIR15/800NR	AGRIgomma R 15 mm NERO	120 cm	su misura	38,112
AGRIR20/800NR	AGRIgomma R 20 mm NERO	120 cm	su misura	52,225
AGRIL10/800NR	AGRIgomma L 10 mm NERO	120 cm	su misura	28,227
AGRIL15/800NR	AGRIgomma L 15 mm NERO	120 cm	su misura	42,341

* peso max per bancale: 1.000 Kg ** Lastre non standard € 20,00 a bancale



DAMPGYM



piastrella in gomma rigata per palestre e box



Articolo	Dimensioni cm	Prezzo €/pz
DAMPGYMR001	Piastrella in gomma 100 x 100 x 15h	49,504
DAMPGYMR002	Piastrella in gomma 60 x 60 x 15h	14,784
DAMPGYMR003	Piastrella in gomma 50 x 50 x 15h	12,544
DAMPGYML004	Piastrella in gomma 100 x 100 x 10h	36,736
DAMPGYML005	Piastrella in gomma 60 x 60 x 10h	10,976
DAMPGYML006	Piastrella in gomma 50 x 50 x 10 h	9,296

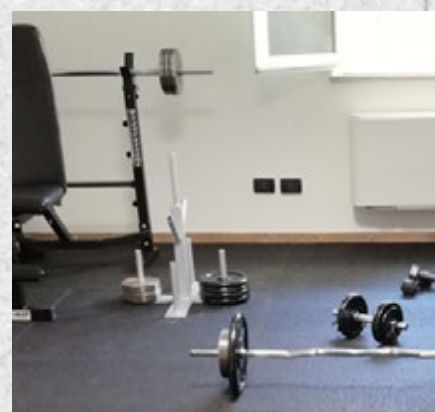
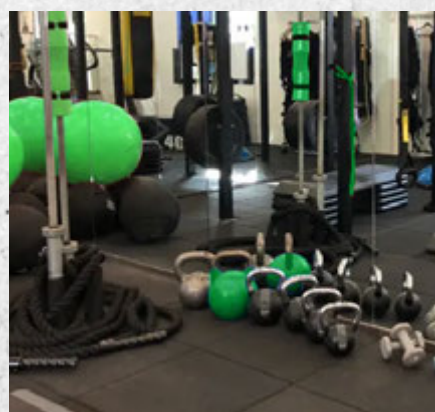



DAMPROLL

materassino acustico anticalpestio



Articolo	Misura rotolo h 125 cm x l 8,00 ml	Imballo per Pallet	Dimensioni Pallet cm	Prezzo €/m ²
DAMPROLL 3	n° 36 rotoli	10 m ² cad. = 360 m ²	120 x 120 x 140	7,525
DAMPROLL 4	n° 25 rotoli	10 m ² cad. = 250 m ²		8,738
DAMPROLL 5	n° 25 rotoli	10 m ² cad. = 250 m ²		9,943
DAMPROLL 6	n° 25 rotoli	10 m ² cad. = 250 m ²		11,157
DAMPROLL 8	n° 16 rotoli	10 m ² cad. = 160 m ²		12,932
DAMPROLL 10	n° 25 rotoli x 4 ml	5 m ² cad. = 125 m ²		16,632

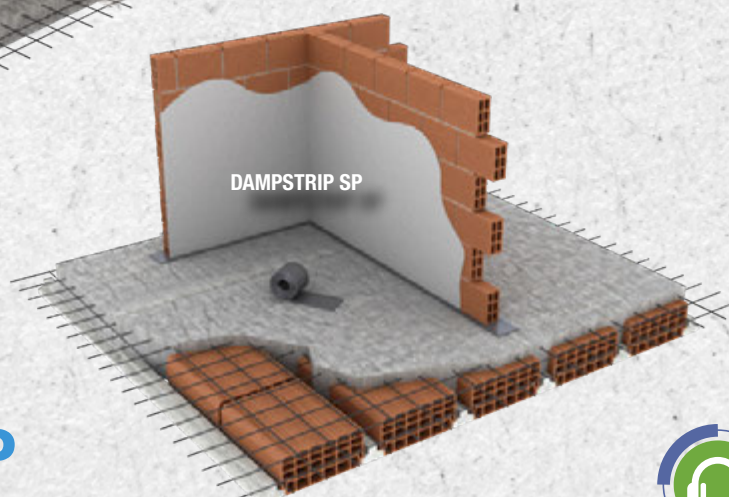
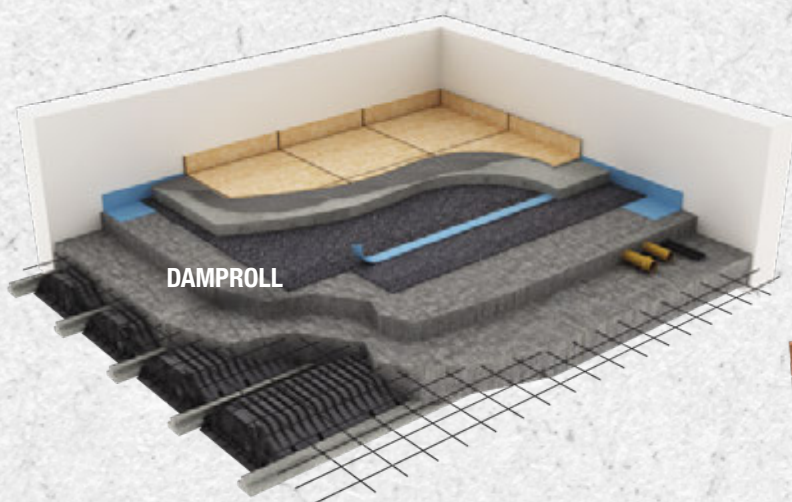

DAMPSTRIP SP

strisce in gomma sottoparete



Articolo	Dimensioni cm	Prezzo €/ml 3mm	Prezzo €/ml 5mm	Prezzo €/ml 8mm
DAMP STRIP SP 15	800 x 15	1,298	1,492	2,002
DAMP STRIP SP 20	800 x 20	1,731	1,996	2,668
DAMP STRIP SP 25	800 x 25	2,163	2,503	3,334
DAMP STRIP SP 30	800 x 30	2,597	3,008	4,002
DAMP STRIP SP 35	800 x 35	3,028	3,502	4,668
DAMP STRIP SP 40	800 x 40	3,460	4,006	5,335
DAMP STRIP SP 45	800 x 45	3,894	4,512	6,004
DAMP STRIP SP 50	800 x 50	4,327	5,005	6,670
DAMP STRIP SP 55	800 x 55	4,760	5,510	7,336
DAMP STRIP SP 60	800 x 60	5,191	6,005	8,004

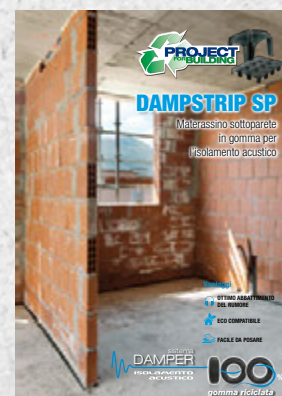



DAMPTILE

sottopiastrella in gomma



Articolo	Dimensioni cm	Imballo	Dimensioni imballo cm	Prezzo €
DAMPTILE lastra	80 x 120	pz 200 = m ² 192	80x120x120	m ² 12,539
DAMPTILE rotolo	125 x 800	pz 25 = m ² 250	120x120x140	m ² 12,539
BIOSCOTCH	Scotch non spessorato da 25 ml			ml. 0,907

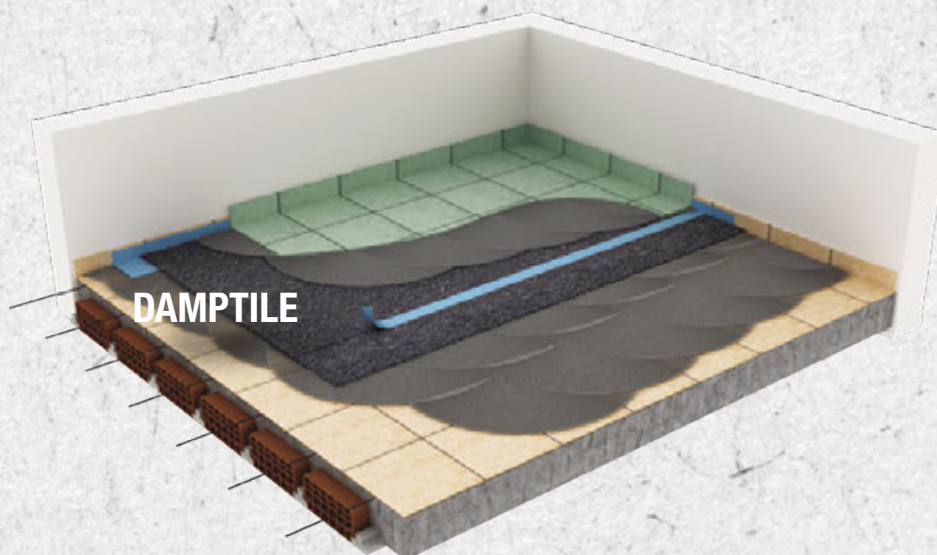

DAMPARQUET

tappetino in gomma sottoparquet



Articolo	Misura rotolo h 1,25 m x l 8,00 ml	Imballo per Pallet	Dimensioni Pallet (ml)	Prezzo €/m ²
DAMPARQUET 3	n° 36 rotoli	10 m ² cad. = 360 m ²	1,20 x 1,20 x 1,40	8,119





SILEREX

premiscelato sfuso in gomma



Articolo	Imballo per Pallet		Dimensioni Pallet (ml)	Prezzo €/Conf.
SILEREX composto premiscelato	n° 45 confezioni	22 kg/cad. = 990 kg	1,20 x 1,20 x 1,60	58,090 (€/kg 2,640)



Accessori per isolamento a pavimento

Articolo	Descrizione	Dimensioni (cm)	Imballo	Prezzo €/ml
DAMP STRIP L	fascia perimetrale adesiva termoformata	(8+10) x 5.000 x 0,5 (sp.)	n° 1 rotolo da 50 ml	1,378
DAMP SCOTCH	nastro di giunzione adesivo	6 x 10.000 x 0,3 (sp.)	n° 1 rotolo da 100 ml	0,803
DAMP STRIP BS	guarnizione elastica per battiscopa	1 x 2.000 x 0,1 (sp.)	n° 5 rotoli da 20 ml	0,310



DAMPSHAKE

antivibrante multiuso in gomma riciclata



Articolo	Dimensioni cm	KIT	Prezzo €
DAMPSHAKE ANTIVIBRANTE (n. 4 pezzi) sp. 10 mm	6 x 6	8 pezzi	6,467
DAMPSHAKE ANTIVIBRANTE (n. 4 pezzi) sp. 10 mm	8 x 8	4 pezzi	8,008
DAMPSHAKE ANTIVIBRANTE (n.4 pezzi) sp. 10 mm	10 x 10	4 pezzi	9,548
DAMPSHAKE ANTIVIBRANTE sp. 10 mm	60 x 60		pz. 10,752
DAMPSHAKE ANTIVIBRANTE sp. 10 mm	80 x 120		pz. 28,448





DAMPWALL

barriera acustica



Articolo	Descrizione	Spessore	Imballo	Dimensioni Imballo cm.	Prezzo €/Mq
DAMPWALL L	lastra da 80 x 120 cm	5 mm	Pz. 100	80 x 120 x 120	12,356
		10 mm	Pz. 100	80 x 120 x 120	23,535
DAMPWALL R	lastra da 80 x 120 cm	10 mm	Pz. 100	80 x 120 x 120	21,181
		15 mm	Pz. 80	80 x 120 x 120	31,181
		20 mm	Pz. 60	80 x 120 x 120	43,568
DAMPWALL AL	lastra da 200/270/280/290/300 x 120 cm	17,5 mm	Pz. 30	lastra 12,5 + 5 mm di gomma	22,329
		22,5 mm	Pz. 25	lastra 12,5 + 10 mm di gomma	34,498
DAMPWALL AR	lastra da 200/270/280/290/300 x 120 cm	22,5 mm	Pz. 30	lastra 12,5 + 10 mm di gomma	32,030
		27,5 mm	Pz. 25	lastra 12,5 + 15 mm di gomma	42,993
		32,5 mm	Pz. 20	lastra 12,5 + 20 mm di gomma	49,366

* peso max per bancale: 1.000 Kg ** Spese per imballo Accoppiati (AR/AL) € 20,00 a bancale / Lastre non standard € 20,00 a bancale

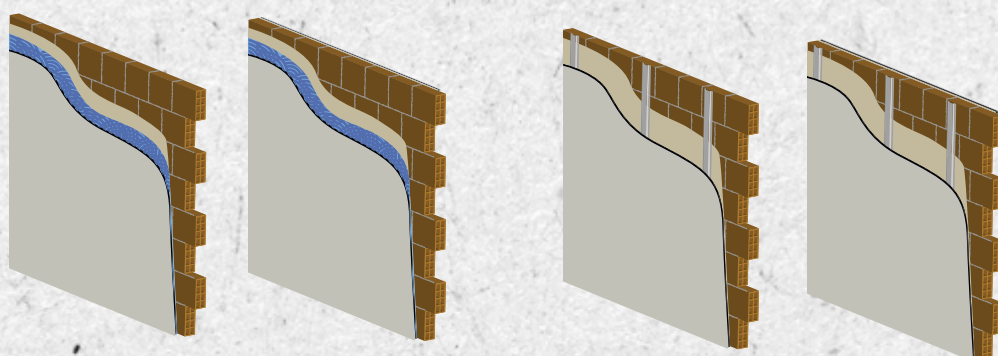

VERSIONI DISPONIBILI

DAMPWALL lastra liscia (L) / lastra rigata (R)

DAMPWALL lastra accoppiata liscia (AL) / lastra accoppiata rigata (AR)



DAMPDRY

pareti a secco fonoisolanti

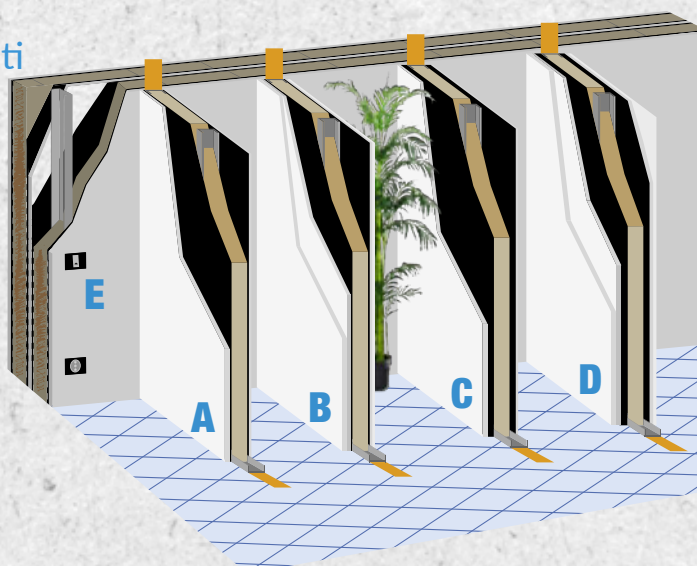

Articolo	Descrizione	Spessore	Imballo	Dimensioni Imballo cm.	Prezzo €/Mq
DAMPDRY 7.5	Lastra da 120 x 200 cm	7,5 mm	30 lastre	120 x 200 x 80	28,294
DAMPDRY 7.5 DOPPIO	Lastra da 120 x 200 cm	7,5+7,5 mm	20 lastre	120 x 200 x 80	51,613
DAMPDRY 20	Lastra da 120 x 200 cm	20,0 mm	20 lastre	120 x 200 x 80	60,600

* peso max per bancale: 1.000 Kg ** Lastre non standard € 20,00 a bancale



PROJECT BINS

NOVITA'
2021

cassoni granvolume per la raccolta e stoccaggio di frutta e verdura



Modello	Altezza mm	Accessori	Peso kg (+ - 5%)	Prezzo €
PROJECT BINS 1000 x 1200 mm	780	4 piedi	37,00	100,000
	780	2 traverse	37,90	102,400
	780	4 traverse	40,05	108,200
PROJECT BINS 1130 x 1130 mm	735	4 piedi	37,90	102,500
	785	4 piedi	39,90	107,800



PROJECT BOX

NOVITA'
2021

cassoni granvolume multiuso per il settore industriale



Modello	Altezza mm	Accessori	Peso kg (+ - 5%)	Prezzo €
PROJECT BOX 1000 x 1200 mm	780	4 piedi	39,85	108,000
	780	2 traverse	40,75	110,400
	780	4 traverse	42,90	116,100
PROJECT BOX 1130 x 1130 mm	735	4 piedi	40,90	110,500
	785	4 piedi	42,90	115,900





edilizia



acustica



garden



bins



stampaggio
conto terzi

Project For Building è conosciuta sul mercato per la sua appartenenza al settore edile, ma negli anni i comparti a cui si è affacciata sono diversi, con numeri costantemente in crescita. Questo è stato possibile grazie alla flessibilità e alla dinamicità che da sempre caratterizza l'azienda, che con l'evolversi del mercato ha saputo adattarsi alle necessità e ha sviluppato prodotti e servizi anche lontani dal principale settore di appartenenza. Granchio il nostro cassero a perdere per la realizzazione di vespai areati, è il prodotto con cui Project For Building ha saputo farsi conoscere, ma dall'edilizia si è passati al garden, e con il Sistema Damper si è arrivati all'isolamento acustico. Ha poi investito nello stampaggio plastica ad iniezione, anche conto terzi, con macchinari esclusivi di grosso tonnellaggio.

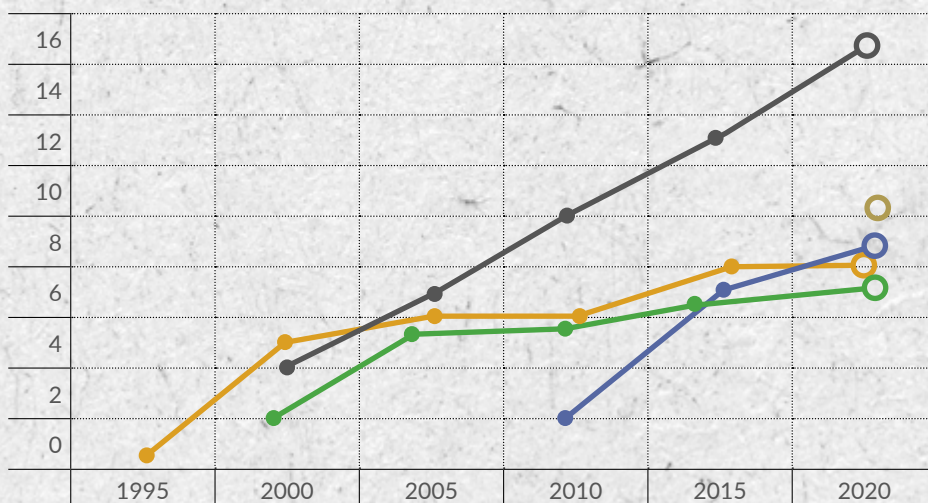

8
articoli



9
articoli



7
articoli



10
articoli



15
presse

139
depositi in Italia

20
depositi all'estero



PROJECT FOR BUILDING S.p.a.

📍 24050 MORNICO AL SERIO (BG)
Italy - Via Fornace, snc

☎ Tel. +39 035 4490440

📠 Fax +39 035 4490752

🌐 www.projectforbuilding.com

@ info@projectforbuilding.com

realizzare
riciclando

A row of five circular icons: a house, a location pin, a recycling symbol, a speech bubble, and a social media share icon.